

LOW DROPOUT VOLTAGE REGULATOR

■ GENERAL DESCRIPTION

The NJM2880 is a low dropout voltage regulator. Advanced Bipolar technology achieves low noise, high ripple rejection and low quiescent current.

■ PACKAGE OUTLINE

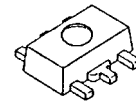

NJM2880U/U1

■ FEATURES

- High Ripple Rejection 70dB typ. (f=1kHz,Vo=3V Version)
- Output Noise Voltage $V_{no}=30\mu V_{rms}$ typ.(Cp=0.01 μ F)
- Output capacitor with 1.0 μ F ceramic capacitor
- Output Current $I_o(max.)=300mA$
- High Precision Output $V_o\pm 1.0\%$
- Low Dropout Voltage 0.10V typ. ($I_o=100mA$)
- ON/OFF Control (Active High)
- Internal Short Circuit Current Limit
- Internal Thermal Overload Protection
- Bipolar Technology
- Package Outline SOT-89-5

■ PIN CONFIGURATION

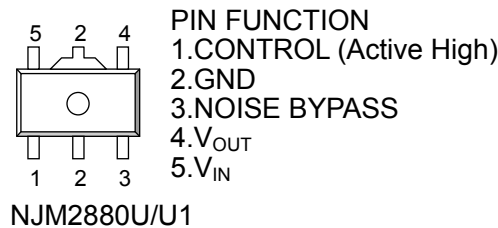

■ EQUIVALENT CIRCUIT

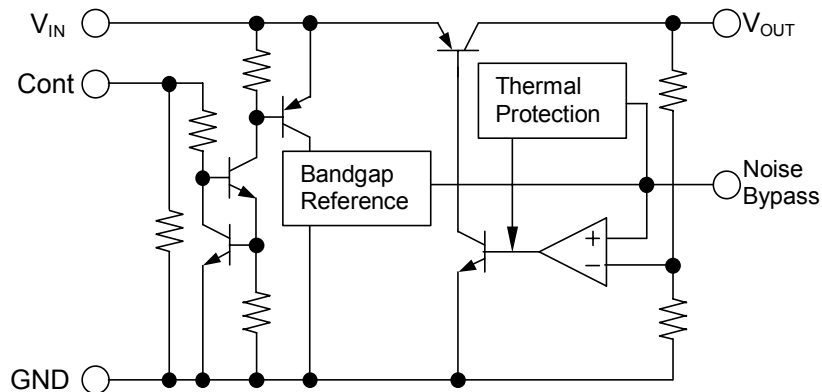

■ OUTPUT VOLTAGE RANK LIST

Device Name	Vout	Device Name	Vout	Device Name	Vout
NJM2880U/U1-15	1.5V	NJM2880U/U1-28	2.8V	NJM2880U/U1-44	4.4V
NJM2880U/U1-16	1.6V	NJM2880U/U1-285	2.85V	NJM2880U/U1-45	4.5V
NJM2880U/U1-18	1.8V	NJM2880U/U1-03	3.0V	NJM2880U/U1-48	4.8V
NJM2880U/U1-21	2.1V	NJM2880U/U1-32	3.2V	NJM2880U/U1-05	5.0V
NJM2880U/U1-25	2.5V	NJM2880U/U1-33	3.3V		
NJM2880U/U1-26	2.6V	NJM2880U/U1-38	3.8V		
NJM2880U/U1-27	2.7V	NJM2880U/U1-04	4.0V		

■ ABSOLUTE MAXIMUM RATINGS (Ta=25°C)

PARAMETER	SYMBOL	RATINGS	UNIT
Input Voltage	V_{IN}	+14	V
Control Voltage	V_{CONT}	+14(*1)	V
Power Dissipation	P_D	350	mW
Operating Temperature	Topr	-40 ~ +85	°C
Storage Temperature	Tstg	-40 ~ +125	°C

(*1) When input voltage is less than +14V, the absolute maximum control voltage is equal to the input voltage.

■ Operating voltage

$V_{IN}=+2.3 \sim +14V$ (In case of $V_o < 2.1V$ version)

■ ELECTRICAL CHARACTERISTICS

($V_o > 2.0V$ version:

$V_{IN}=V_o+1V$, $C_o=0.1\mu F$: $V_o \geq 2.7V$ ($C_o=2.2\mu F$: $V_o \leq 2.6V$), $C_p=0.01\mu F$, $T_a=25^\circ C$)

PARAMETER	SYMBOL	TEST CONDITION	MIN.	TYP.	MAX.	UNIT
Output Voltage	V_o	$I_o=30mA$	-1.0%	-	+1.0%	V
Quiescent Current	I_Q	$I_o=0mA$, expect I_{cont}	-	120	180	μA
Quiescent Current at Control OFF	$I_{Q(OFF)}$	$V_{CONT}=0V$	-	-	100	nA
Output Current	I_o	$V_o-0.3V$	300	400	-	mA
Line Regulation	$\Delta V_o / \Delta V_{IN}$	$V_{IN}=V_o+1V \sim V_o+6V$, $I_o=30mA$	-	-	0.10	%/V
Load Regulation	$\Delta V_o / \Delta I_o$	$I_o=0 \sim 300mA$	-	-	0.03	%/mA
Dropout Voltage	ΔV_{I-O}	$I_o=100mA$	-	0.10	0.18	V
Ripple Rejection	RR	$e_{in}=200mV_{rms}$, $f=1kHz$, $I_o=10mA$ $V_o=3V$ Version	-	70	-	dB
Average Temperature Coefficient of Output Voltage	$\Delta V_o / \Delta T_a$	$T_a=0 \sim 85^\circ C$, $I_o=10mA$	-	± 50	-	ppm/°C
Output Noise Voltage	V_{NO}	$f=10Hz \sim 80kHz$, $I_o=10mA$, $V_o=3V$ Version	-	30	-	μV_{rms}
Control Voltage for ON-state	$V_{CONT(ON)}$		1.6	-	-	V
Control Voltage for OFF-state	$V_{CONT(OFF)}$		-	-	0.6	V

($V_o \leq 2.0V$ version:

$V_{IN} = V_o + 1V$, $C_{IN} = 0.1\mu F$, $C_o = 2.2\mu F$: $V_o \geq 1.9V$ ($C_o = 4.7\mu F$: $V_o \leq 1.8V$), $C_p = 0.01\mu F$, $T_a = 25^\circ C$)

PARAMETER	SYMBOL	TEST CONDITION	MIN.	TYP.	MAX.	UNIT
Output Voltage	V_o	$I_o = 30mA$	-1.0%	-	+1.0%	V
Quiescent Current	I_Q	$I_o = 0mA$, expect I_{cont}	-	120	180	μA
Quiescent Current at Control OFF	$I_{Q(OFF)}$	$V_{CONT} = 0V$	-	-	100	nA
Output Current	I_o	$V_o - 0.3V$	300	400	-	mA
Line Regulation	$\Delta V_o / \Delta V_{IN}$	$V_{IN} = V_o + 1V \sim V_o + 6V$, $I_o = 30mA$	-	-	0.10	%/V
Load Regulation	$\Delta V_o / \Delta I_o$	$I_o = 0 \sim 300mA$	-	-	0.03	%/mA
Ripple Rejection	RR	$e_{in} = 200mV_{rms}$, $f = 1kHz$, $I_o = 10mA$ $V_o = 1.8V$ Version	-	74	-	dB
Average Temperature Coefficient of Output Voltage	$\Delta V_o / \Delta T_a$	$T_a = 0 \sim 85^\circ C$, $I_o = 10mA$	-	± 50	-	ppm/ $^\circ C$
Output Noise Voltage	V_{NO}	$f = 10Hz \sim 80kHz$, $I_o = 10mA$, $V_o = 1.8V$ Version	-	18	-	μV_{rms}
Control Voltage for ON-state	$V_{CONT(ON)}$		1.6	-	-	V
Control Voltage for OFF-state	$V_{CONT(OFF)}$		-	-	0.6	V

The above specification is a common specification for all output voltages.

Therefore, it may be different from the individual specification for a specific output voltage.

■ TEST CIRCUIT

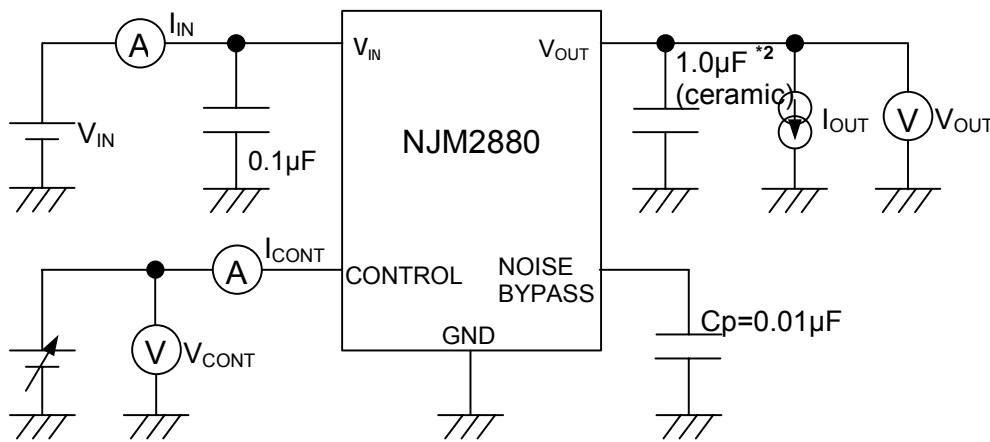

*2 $1.9V \leq V_o \leq 2.6V$ version : $C_o = 2.2\mu F$ (ceramic)
 $V_o \leq 1.8V$ version : $C_o = 4.7\mu F$ (ceramic)

■ TYPICAL APPLICATION

① In the case where ON/OFF Control is not required:

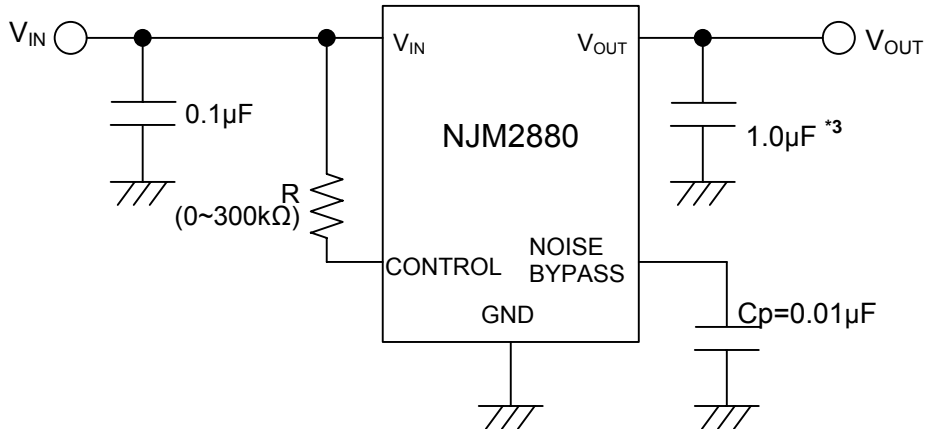

*3 1.9V ≤ Vo ≤ 2.6V version : Co = 2.2µF
Vo ≤ 1.8V version : Co = 4.7µF

Connect control terminal to V_{IN} terminal

② In use of ON/OFF CONTROL:

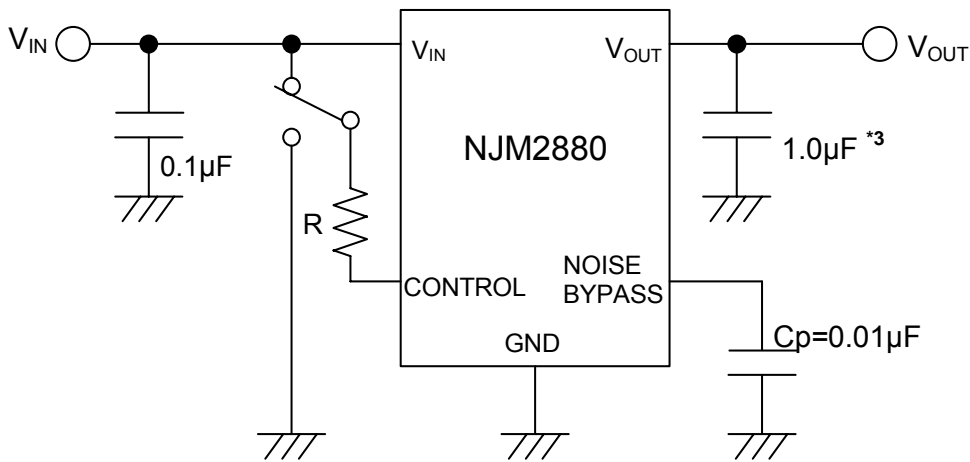

*3 1.9V ≤ Vo ≤ 2.6V version : Co = 2.2µF
Vo ≤ 1.8V version : Co = 4.7µF

State of control terminal:

- “H” → output is enabled.
- “L” or “open” → output is disabled.

*Noise bypass Capacitance Cp

Noise bypass capacitance Cp reduces noise generated by band-gap reference circuit. Noise level and ripple rejection will be improved when larger Cp is used. Use of smaller Cp value may cause oscillation. Use the Cp value of 0.01µF greater to avoid the problem.

*In the case of using a resistance "R" between V_{IN} and control.

The current flow into the control terminal while the IC is ON state (I_{CONT}) can be reduced when a pull up resistance "R" is inserted between V_{IN} and the control terminal. The minimum control voltage for ON state (V_{CONT(ON)}) is increased due to the voltage drop caused by I_{CONT} and the resistance "R". The I_{CONT} is temperature dependence as shown in the "Control Current vs. Temperature" characteristics. Therefore, the resistance "R" should be carefully selected to ensure the control voltage exceeds the V_{CONT(ON)} over the required temperature range.

■ ELECTRICAL CHARACTERISTICS

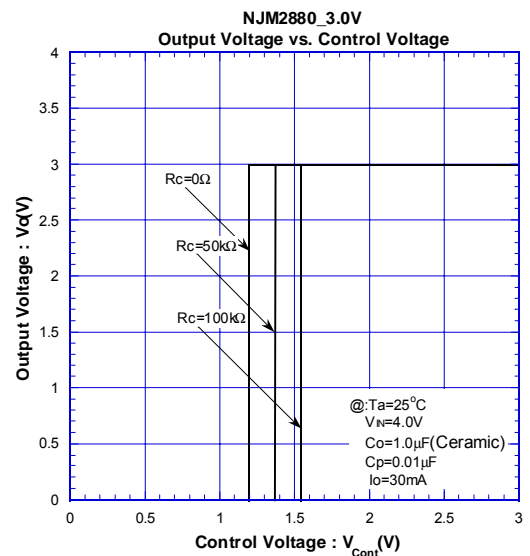
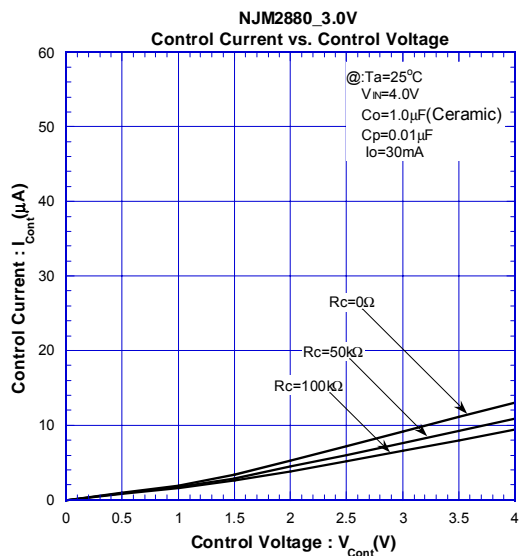
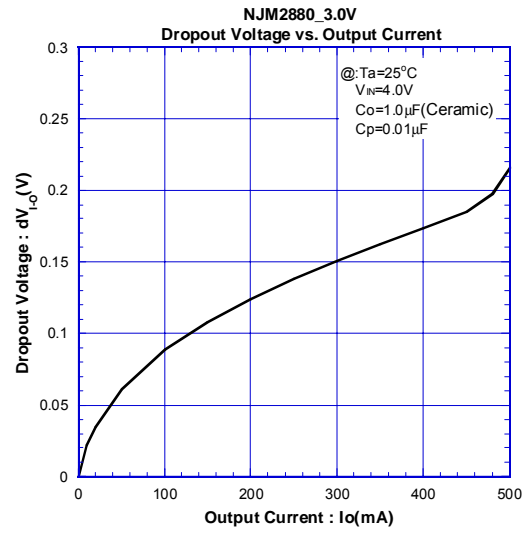
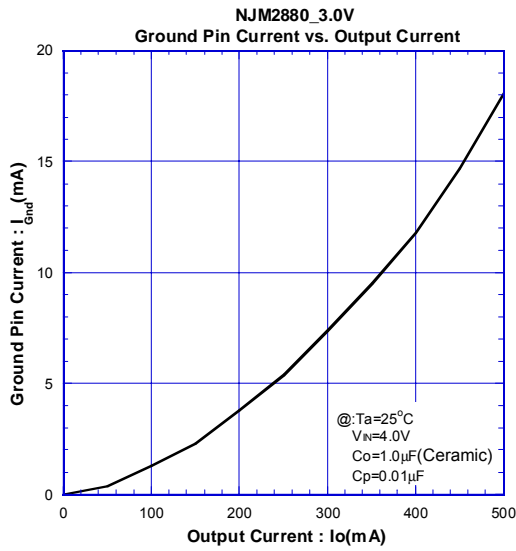
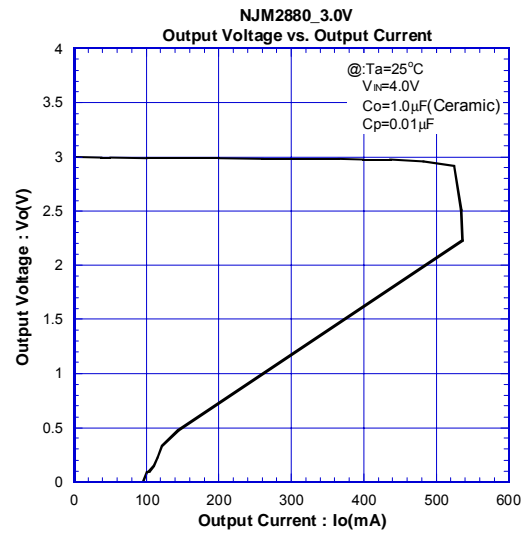
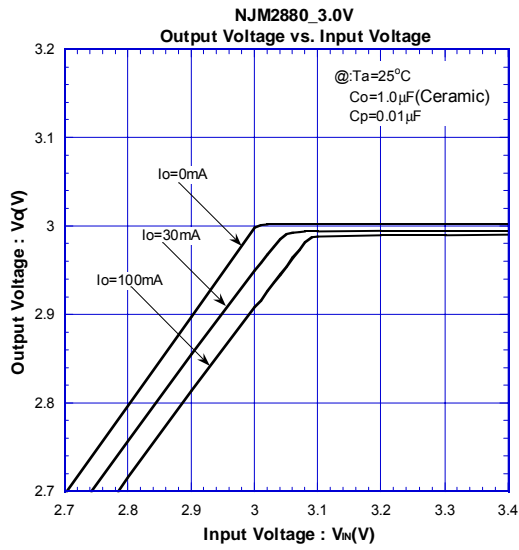

ELECTRICAL CHARACTERISTICS

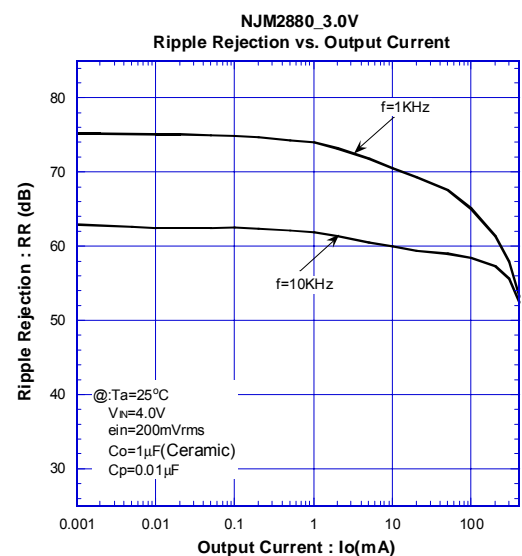
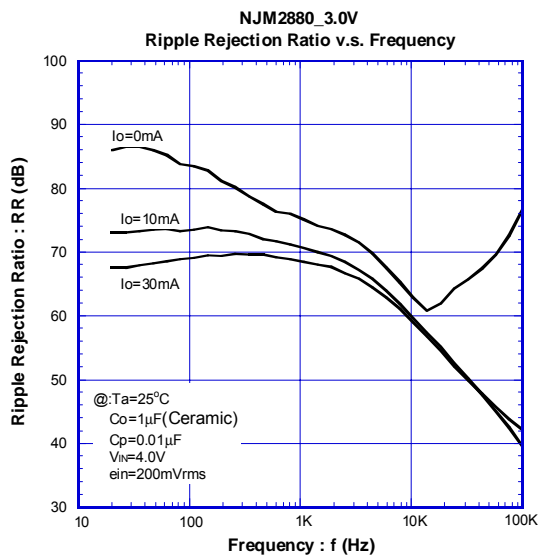
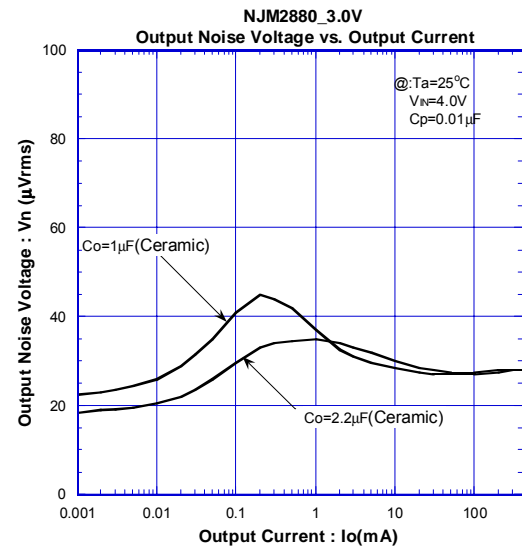
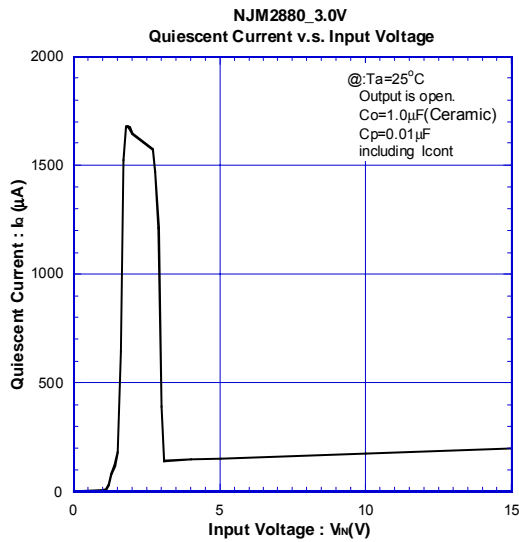
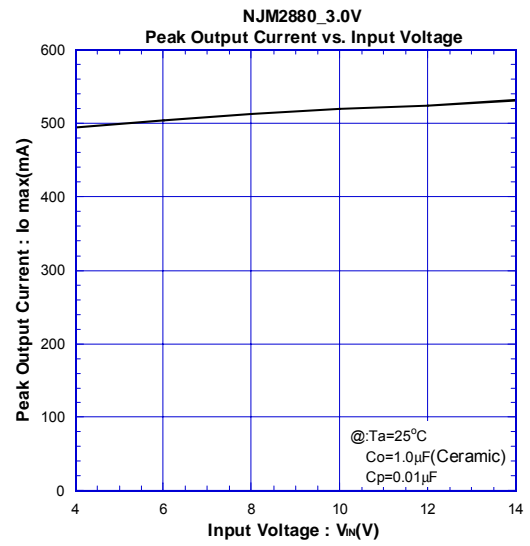
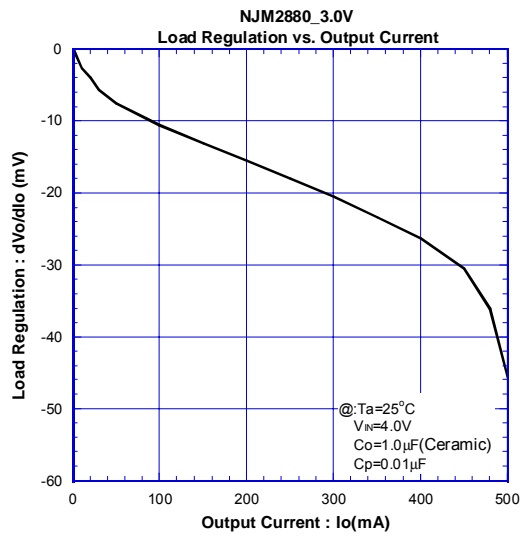

ELECTRICAL CHARACTERISTICS

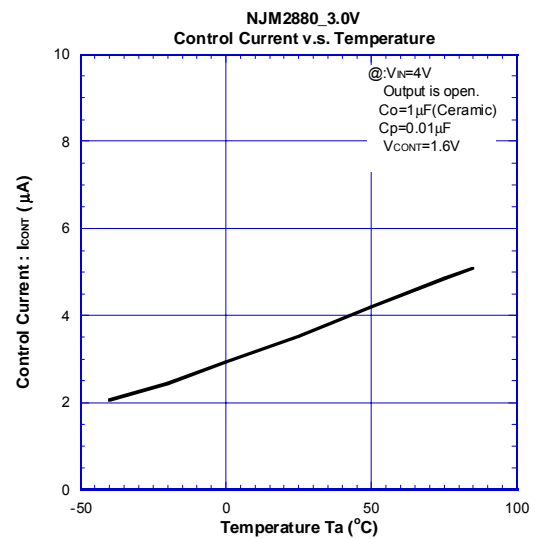
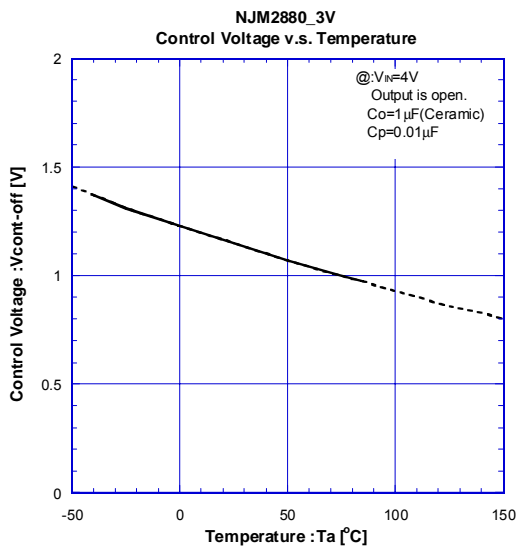
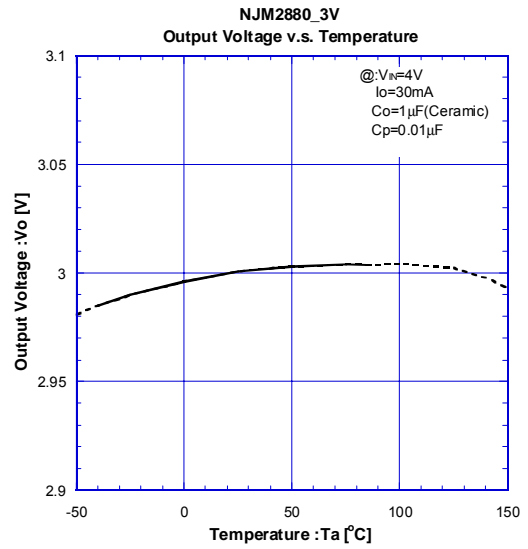
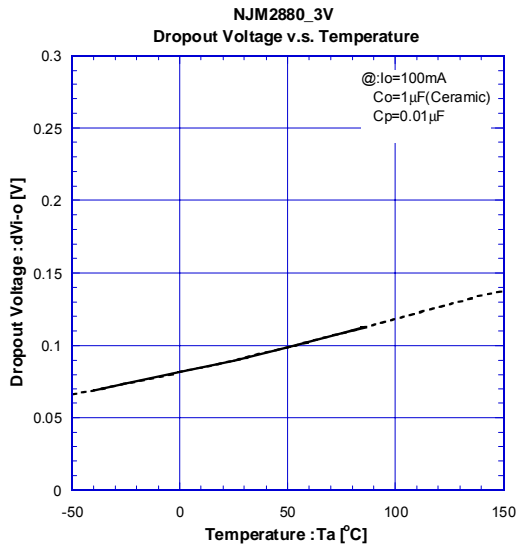
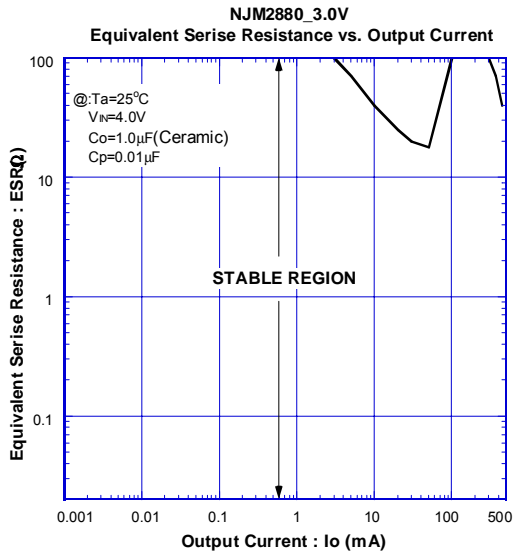

ELECTRICAL CHARACTERISTICS

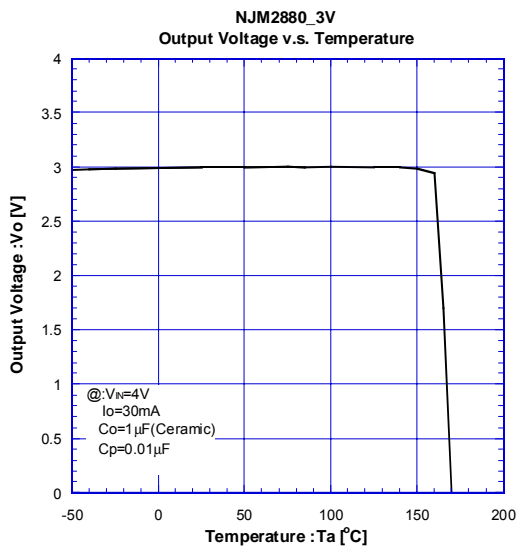
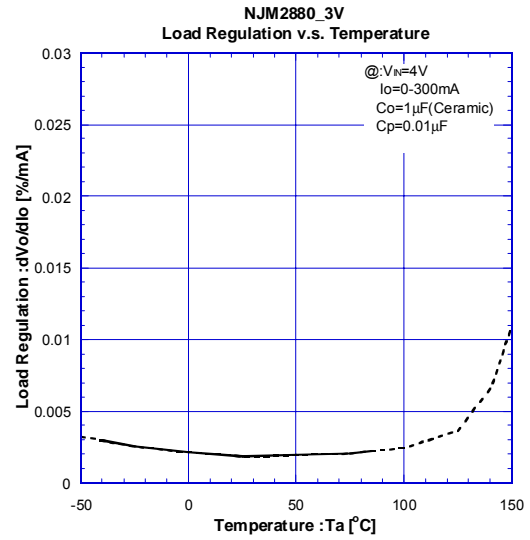
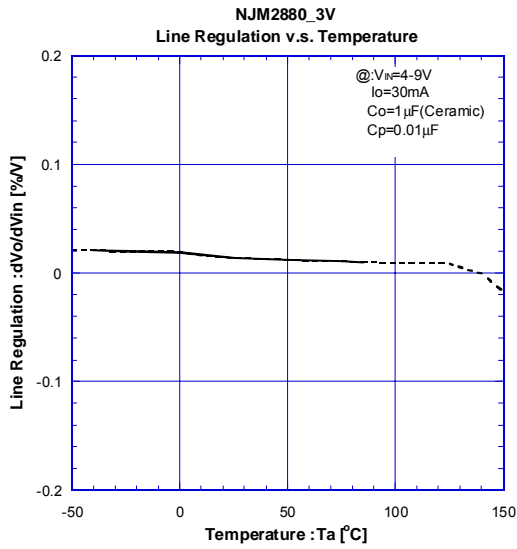
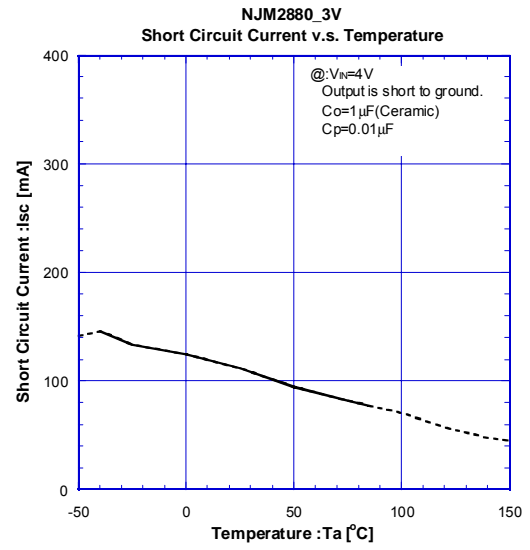
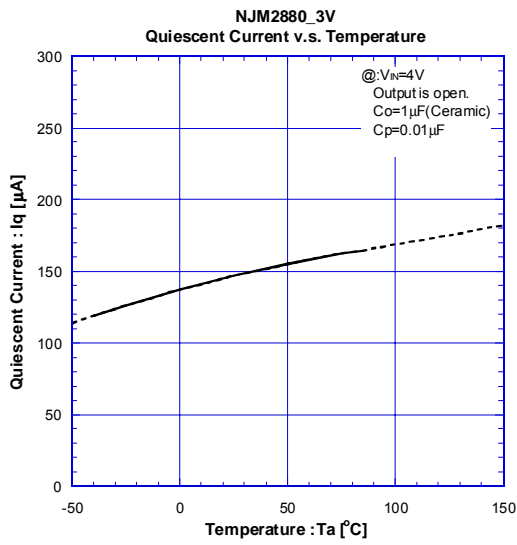

■ ELECTRICAL CHARACTERISTICS

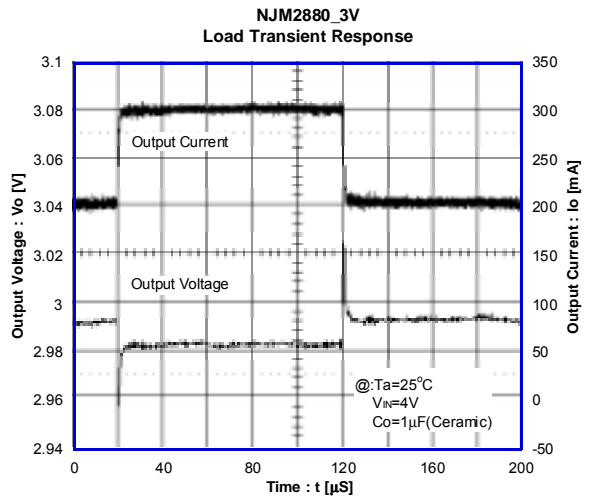
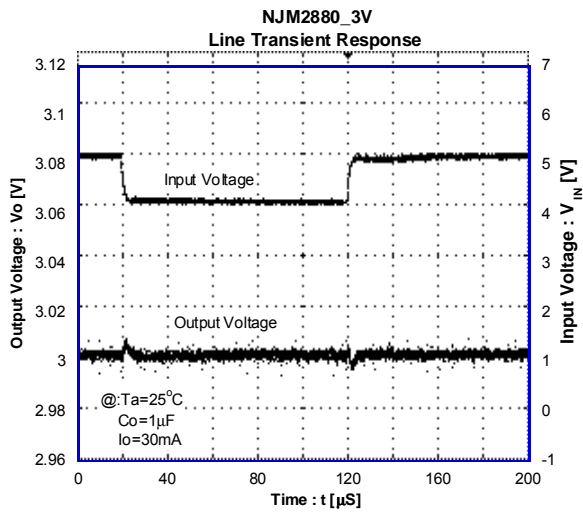
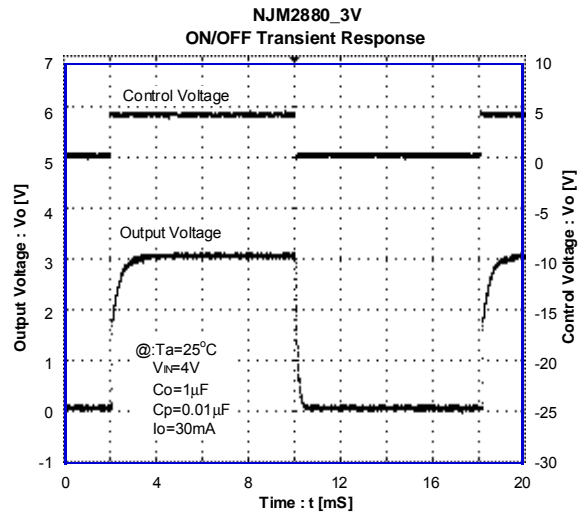
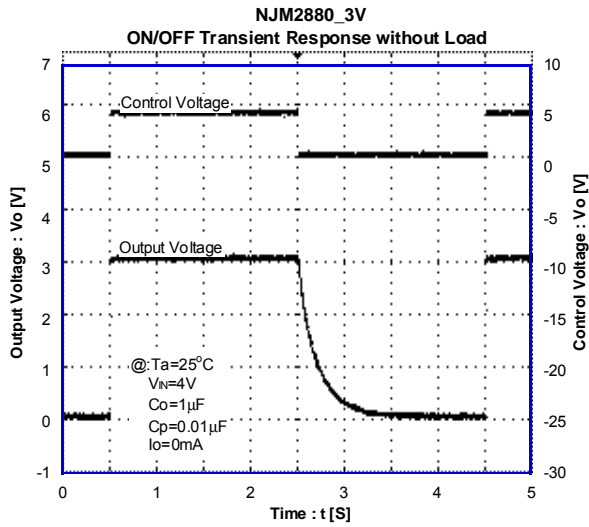

[CAUTION]

The specifications on this databook are only given for information, without any guarantee as regards either mistakes or omissions. The application circuits in this databook are described only to show representative usages of the product and not intended for the guarantee or permission of any right including the industrial rights.

Mouser Electronics

Authorized Distributor

Click to View Pricing, Inventory, Delivery & Lifecycle Information:

Nisshinbo Micro Devices:

[NJM2880U1-32-TE1](#) [NJM2880U1-03-TE1](#) [NJM2880U1-15-TE1](#) [NJM2880U1-285-TE1](#) [NJM2880U1-03-TE2](#)
[NJM2880U1-33-TE2](#) [NJM2880U1-38-TE1](#) [NJM2880U1-04-TE1](#) [NJM2880U1-25-TE1](#) [NJM2880U1-48-TE1](#)
[NJM2880U1-45-TE1](#) [NJM2880U1-16-TE1](#)